

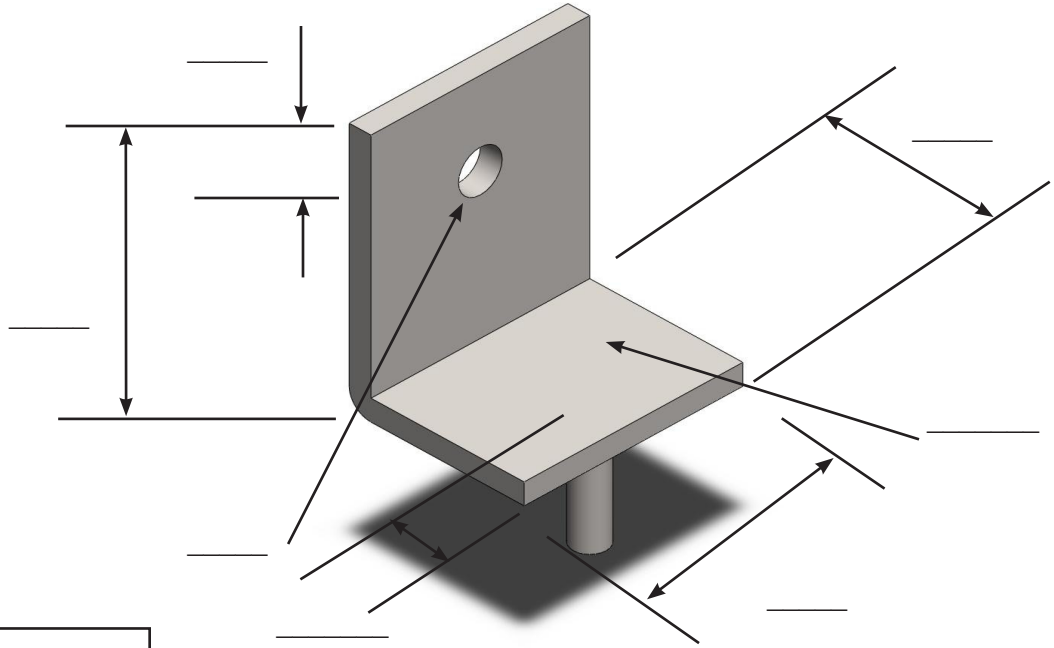

CUSTOM STAINLESS STEEL INC. CUSTOM STONE ANCHORS

STONE BRACKET - "L-3"



QUANTITY: _____

FINISH:

- TYPE 304 Stainless Steel
- TYPE 316 Stainless Steel

THICKNESS:

- 12 Ga. / 2.78 mm 1/4" / 6.3 mm
- 1/8" / 3.2 mm
- 3/16" / 4.7 mm OTHER : _____

Project Name : _____

Company Name : _____

Location : _____

Address : _____

Notes : _____

Phone : _____

Fax : _____

Email : _____

The appropriate selection and use of any CSS Inc. Custom Stone Brackets must be determined by qualified architects, engineers or other professionals who are familiar with the specific requirements of the project.



CUSTOM STAINLESS STEEL INC.
8426-C San Fernando Road.
Sun Valley, CA 91352

Tel : (818) 252-7174
Fax : (818) 252-6853
E-Mail : sales@cstainless.com
Website : www.cstainless.com